



AGRI SAV
MACCHINE AGRICOLE

Via delle Concerie, 1
12038 - Savigliano (CN)
Tel: 0172 21847 - Fax: 0172 21847
E-mail: info@agrisav.it

www.agrisav.it



FOREST LOADER

P.A.S. 350

P.A.S. 350

TECHNICAL DATA

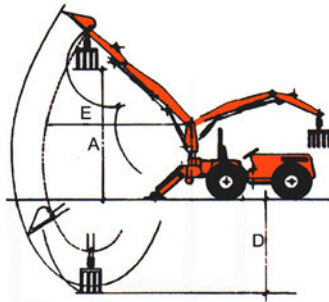

Max arm length (mm) [E]:	3500
Max height (mm) [A]:	5000
Max depth (mm) [D]:	1900
Lifting weight in outstretched arm (Kg):	350
Loader weight (Kg):	480
Rotation:	360° (not continued)
Telescope length (mm):	500
Oil system (L):	40
PTO (rpm):	540
Working pressure (bar):	180
Power required (Hp):	35/50

Standard equipment:

- Universal three-point attacks
- Pump with oil reservoir
- Independent hydraulic feet
- Hydraulic telescopic arm
- The driving position with the seat

Accessories:

- Closed bucket
- Excavating bucket 20 cm
- Excavating bucket 30 cm
- Ditch cleaning bucket
- Manure fork
- Joystick controls
- 2 foot controls
- Radio control
- Servo control
- Multiplier with tail shaft passer
- Mounting brackets
- Continuous rotor QL 10 RBI
- Grapple for trunks mm 1100
- Reversible arm Z

